

PRO DECOR

Inspired by Life

Handle Collection



Technik für Möbel

  
**Hettich**

# ProDecor – Inspired by Life

## Summary

### Key

All measurements in mm

We do not recommend using power tools to tighten the handle screws.

All natural materials may vary in colour and structure from those depicted.

 Length or width

All threads are metric



 Height

 Hole distance

 Packaging unit

### Cleaning products for handles and knobs:

- ▶ Please use a soft, lint free cloth and mild water-soluble detergents such as liquid or neutral soap.
- ▶ Do not use any abrasive cleaners, scouring pads, cellulose thinners or irritant/corrosive chemicals as these may damage the surface over time!
- ▶ Marks should always be removed as quickly as possible to prevent them from staining the surface.

 Cut to size



**NEW MODERN style world**

**Summary**  
**Handles and knobs**

**4**  
**6 - 25**



**DELUXE style world**

**Summary**  
**Handles and knobs**

**26**  
**28 - 31**



**ORGANIC style world**

**Summary**  
**Handles and knobs**

**32**  
**34 - 41**



**FOLK style world**

**Summary**  
**Handles and knobs**

**42**  
**44 - 49**



**Accessories, work assistants**  
**Summary by materials**  
**Index**  
**Order numbers**

**50 - 59**  
**60 - 61**  
**62**  
**63 - 65**

Interior design is an expression of personal style. This is why there are four ProDecor style worlds: for homes with personality.

## NEW MODERN



## DELUXE



### **Technology. Transparency. Practicality.**

NEW MODERN impresses with its clear cut, futuristic style and cool touch. Purist looking furniture fronts in masterful perfection.

### **Homes that speak to the senses – with a touch of luxury:**

Shimmering metals and majestic colours define the DELUXE style world. The powerful handle design conjures an ambience that pleases the senses, extending an irresistible invitation to touch ...

## ORGANIC



### **The idyll of unspoiled nature.**

This collection is fired by organic shapes and natural looking, rough feeling finishes. Want to live with nature's charm? Welcome to the world of ORGANIC style!

## FOLK



### **Furniture handles that tell stories.**

Traditional shapes and colours. Opulent patterns and soft finishes you want to touch. Ingeniously crafted used looks exude appealing warmth. FOLK is pure joy. For your customers too.

# NEW MODERN



6 Velitra



6 Imperia



7 Bermeo

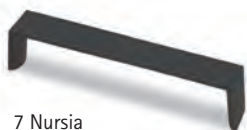

7 Nursia



8/9 Shadowline



10 Cheam



10 Tornea



11 Anzio



11 Aosta



12 Clivia



13 Narona



13 Hale



14 Salvia



14 Nombela



15 Kervo



15 Padula



15 Fermo



16 Stabia



16 Rovigo



18/19 Canis L



20 Genoa



20 Messana



21 Venusia

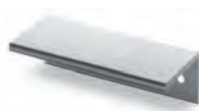

21 Ticinum

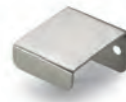

22 Narni

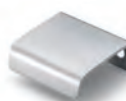

22 Empoli



23



24 Lindavia



24 Lutetia



24 Eslinga



24 Seveso



25 Nidum



# NEW MODERN

## Velitra



Brushed stainless steel look

## Imperia



Brushed stainless steel look

•••	•	□
128 / 192	204	0 115 018 50
224 / 260	272	0 115 014 50
260 / 320	372	0 115 016 25
360 / 416	472	0 115 017 25

•••	•	□
192	220	9 995 585 40
224	252	9 995 586 40
320	348	9 995 587 40
448	476	9 995 588 40
541	569	9 995 589 40
560	588	9 995 590 40

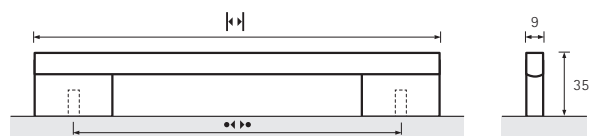
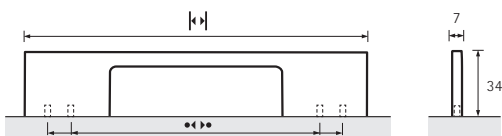



### Bermeo



Matt black /  
Brushed stainless steel look

### Nursia



1 Matt chrome plated



2 Brushed stainless steel look



3 Matt black

•••	•		□
96	109	9 208 081	30
128	141	9 208 082	25
160	173	9 208 083	25
192	205	9 208 084	25
224	237	9 208 085	25
256	269	9 208 086	50
288	301	9 208 087	50
320	333	9 208 088	50

		□
1	9 120 199	25
2	9 112 637	25
3	9 264 087	25

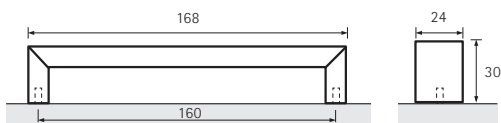
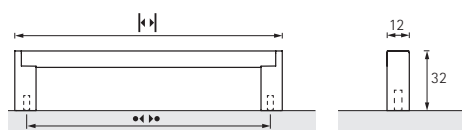

# NEW MODERN

## Shadowline

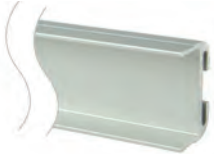

1 42mm Shadowline Handle  
clear anodised



4 52mm Shadowline Handle  
clear anodised



2 42mm Shadowline Handle  
black powder coated



5 52mm Shadowline Handle  
black powder coated



3 42mm Shadowline Handle  
white powder coated



6 52mm Shadowline Handle  
white powder coated

	W	H	Q	Ø
1	42	9 995 920	4	Ø
2	42	9 282 211	4	
3	42	9 282 236	4	

	W	H	Q	Ø
1	52	9 995 910	4	Ø
2	52	9 282 235	4	
3	52	9 282 237	4	

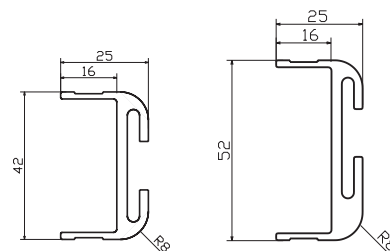
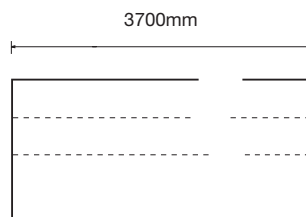
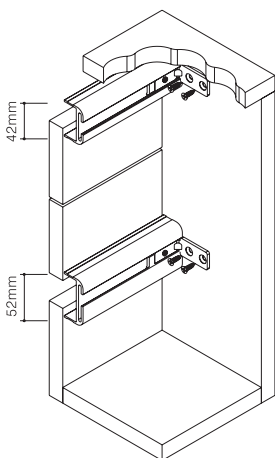

## Shadowline End Clip



Steel zinc plated

	□
9 995 930	100

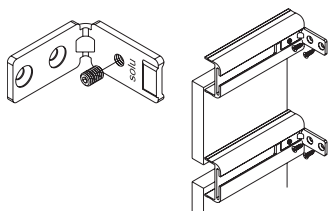

## Shadowline End Caps



1 Satin chrome plated

	□
1 42	1 161 408 100

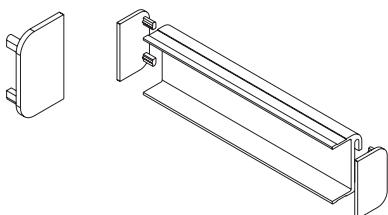

2 Satin chrome plated

	□
2 52	1 161 148 50 pairs

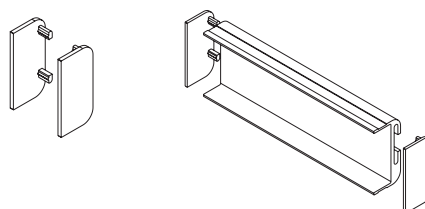

# NEW MODERN

## Cheam



Matt black

## Tornea



1 Bright chrome plated



2 Brushed stainless steel look

•••	•		□
128	163	9 252 428	20
160	195	9 252 429	25
192	227	9 252 430	20

	•••	•		□
1	128	138	9 112 938	50
1	192	202	9 112 941	50
2	128	138	9 112 940	50
2	192	202	9 112 943	50

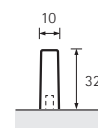
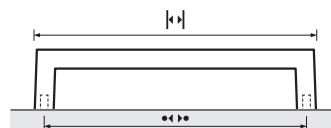
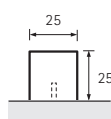
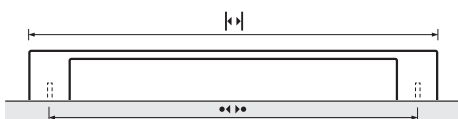

### Anzio



Brushed stainless steel

### Aosta



Brushed stainless steel

•••	•  <sub>1</sub>	•  <sub>2</sub>		□
128	138	10	1 160 018	30
160	170	10	1 160 019	30
192	202	10	9 204 175	40
224	234	10	1 160 020	50
288	298	10	1 160 021	50
320	330	10	9 204 177	50
352	362	10	1 160 022	50
480	490	10	1 160 023	50
608	618	10	1 160 024	50
736	746	10	1 160 025	50

•••	•		□
128	144	9 069 804	50
160	176	9 069 805	25
192	208	9 069 806	25
224	240	9 069 807	25
256	272	9 113 248	40
320	336	9 069 808	25

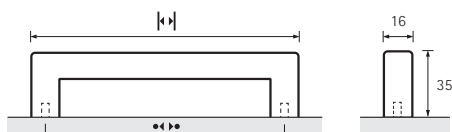
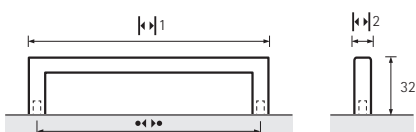

# NEW MODERN

## Clivia



1 Aluminium, anodised



2 Matt chrome plated



3 Brushed stainless steel look



4 Matt black



	•••	•	□
1	96	108	0 115 205 50
1	128	140	0 115 355 50
1	160	172	0 115 353 50
1	232	244	0 115 356 50
1	282	294	0 115 357 25
1	332	344	0 115 358 25
1	382	394	0 115 359 25
1	432	444	0 115 360 25
1	482	494	0 115 361 25
1	532	544	0 115 362 25
1	632	644	0 115 364 25

	•••	•	□
2	128	140	9 995 531 20
2	224	236	9 995 534 30
3	96	108	9 995 535 25
3	128	140	9 995 536 20
3	160	172	9 995 537 30
3	192	204	9 995 538 30
3	224	236	9 995 539 30

	•••	•	□
4	96	108	9 265 888 50
4	128	140	9 265 879 50
4	160	172	9 265 880 50
4	192	204	9 265 921 50
4	224	236	9 265 923 25

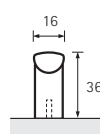
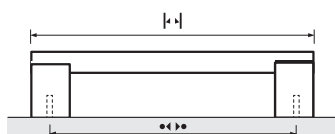

## Narona



Brushed stainless steel

## Hale



1 Bright chrome plated



2 Brushed stainless steel look

•••	•	□
96	108	9 070 970 50
128	140	9 070 973 25
160	172	9 070 975 40
192	204	9 070 992 40
224	236	9 203 963 40
288	300	9 070 995 50
320	332	9 070 998 50
352	364	9 070 977 25
384	396	9 070 979 25
480	492	9 071 000 25
640	652	9 071 010 15
736	748	9 071 013 15

	•••	•	□
1	96	156	9 070 807 20
1	128	188	9 070 809 40
1	288	348	9 070 813 25
	•••	•	□
2	96	156	9 070 674 20
2	128	188	9 070 750 40
2	160	220	9 070 796 40
2	184	244	9 070 746 40
2	234	294	9 070 742 50
2	284	344	9 070 734 50
2	334	394	9 070 733 25
2	384	444	9 070 732 25
2	434	494	9 070 736 25
2	484	544	9 070 738 25

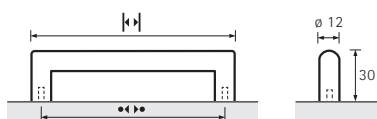

# NEW MODERN

Salvia



Brushed stainless steel

Nombela



Matt black

Ø12



Ø	«»»		□	□
12	96	157	9 071 003	50
12	128	188	9 071 005	50
12	160	220	9 071 008	50
12	256	316	9 071 017	50
12	352	412	9 071 023	20
12	448	508	9 071 026	20

«»»		≡	□	□
96 / 128	157	24	9 252 425	70
160 / 192	221	28	9 252 426	50
288 / 320	349	28	9 252 427	50

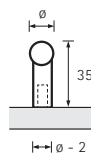
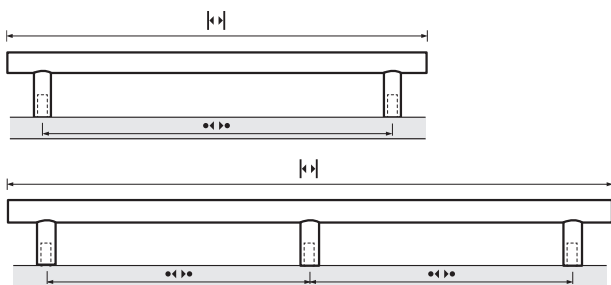



### Kervo



Matt black

•••	•	□
96 / 128	152	9 190 442 100
160 / 192	216	9 190 443 50
224 / 256	280	9 190 444 100

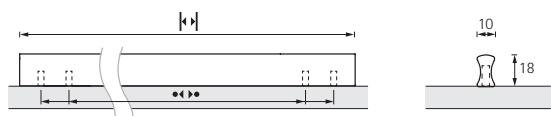

### Fermo



1 Bright chrome plated



2 Brushed stainless steel look

	□
1	0 115 020 50
2	0 115 019 50

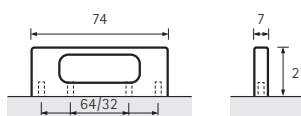

### Padula



Matt black

•••	•	□
192 / 224	242	9 252 419 40

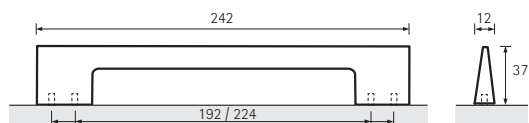

# NEW MODERN

## Stabia



Aluminium, anodised

## Rovigo



Brushed stainless steel look

•••	•		□
96	108	0 115 023	100
128	140	0 115 021	50
160	172	0 115 022	75
224	236	0 115 024	50

•••	•		□
160	175	9 113 298	25
224	239	9 113 300	25

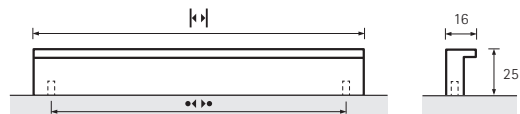
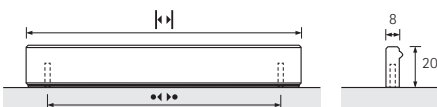



# NEW MODERN

## Canis L



1 Aluminium, anodised



3 90° inside corner / Aluminium look



2 Stainless steel look



4 90° inside corner / Stainless steel look

1	9 210 115	8					
2	9 210 116	8					

3	9 210 117	50					
4	9 210 119	50					



5 90° outside corner / Aluminium look



6 90° outside corner / Stainless steel look



9 Fixing bracket / Galvanised steel



10 Fixing bracket cranked, required when using end caps / Galvanised steel



11 Fixing bracket / Galvanised steel

		☐
5	9 210 122	50
6	9 210 125	50

		☐
9	9 210 142	100
10	9 210 143	100
11	9 210 129	100



7 Set of closed end caps / Aluminium look



8 Set of closed end caps / Stainless steel look

		☐
7	9 210 126	50
8	9 210 128	50

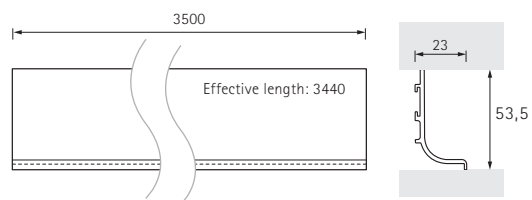

# NEW MODERN

## Genoa



1 Bright chrome plated



2 Brushed stainless steel look

1	9 065 611	30	
2	9 065 612	30	

## Messana



1 Bright chrome plated

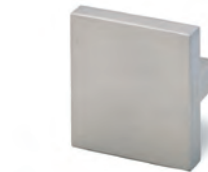

2 Brushed stainless steel look

1	0 115 157	50	
2	0 115 156	50	

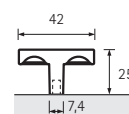
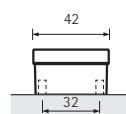
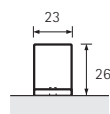
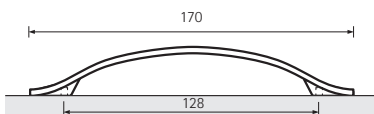

## Venusia



1 Bright chrome plated



2 Brushed stainless steel look

## Ticinum

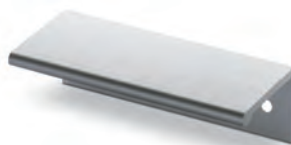

Aluminium, anodised

			☐
1	0 115 155	25	
2	0 115 154	25	

•••	•		☐
70	90	9 070 593	50
8 x 224	2000	9 131 455	12

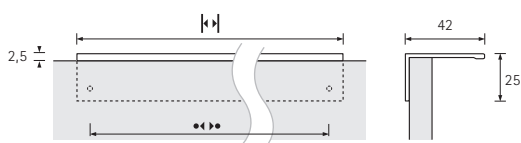
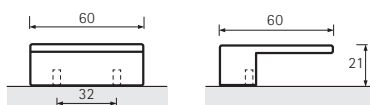

# NEW MODERN

## Narni



Brushed stainless steel

## Empoli



1 Bright chrome plated



2 Matt chrome plated



3 Brushed stainless steel look

•••	••		☐
20	30	9 995 574	75

			☐
1		9 995 541	70
2		9 995 540	70
3		9 995 542	70

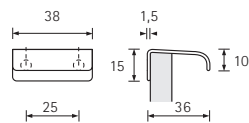
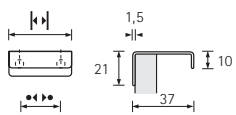



## Lamezia



1 Brushed stainless steel look

	1	2	3
445	9 105 820	25	
495	9 105 821	25	
595	9 105 822	25	
795	9 105 823	25	
895	9 105 824	25	
995	9 105 825	25	



2 Matt black

445	9 265 977	25
495	9 265 978	25
595	9 265 979	25
795	9 265 980	25
895	9 265 981	25
995	9 265 982	25



3 Gold look matt brushed

445	9 265 988	25
495	9 265 989	25
595	9 265 990	25
795	9 265 991	25
895	9 265 992	25
995	9 265 993	25

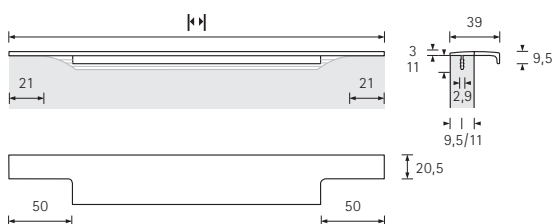

# NEW MODERN

## Lindavia



Aluminium, anodised

0 115 115 12

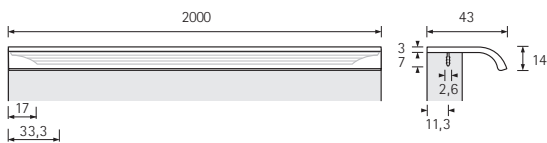

## Lutetia

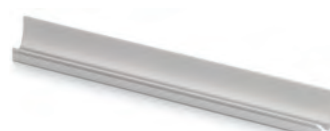

Aluminium, anodised

0 115 091 6

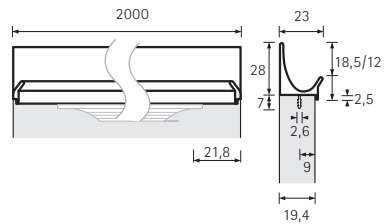

## Eslinga



Aluminium, anodised

0 115 090 4

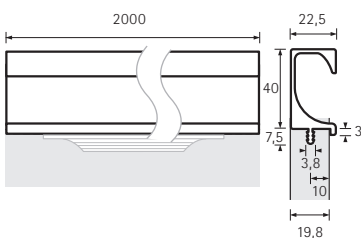

## Seveso



Aluminium, anodised

k1	k2	k3		
17	3	17	9 995 122	6
19	3	19	9 995 123	6

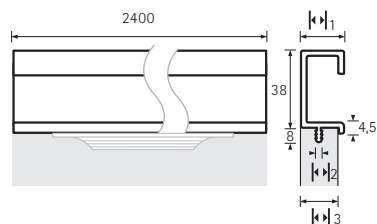

## Nidum



Aluminium look

•••	k <sub>1</sub>	k <sub>2</sub>		□
96	111	107	9 071 060	25
128	143	139	9 071 071	25
160	175	171	9 071 073	25
192	207	203	9 071 075	25
256	271	267	9 071 079	50
320	335	331	9 071 082	50

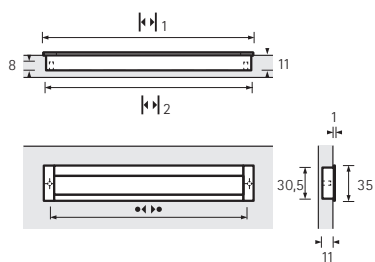

# DELUXE



28 Brema



28 Buena



29 Baldone



29 Belluno



30 Intra



31 Veronia



31 Opera



31 Limpio



# DELUXE

## Brema



1 Brushed stainless steel /  
Brushed stainless steel look



2 Matt black /  
Brushed stainless steel look

	•••			□
1	96	108	9 118 858	25
1	128	140	9 069 890	25
1	160	172	9 069 893	25
1	192	204	9 070 104	25
1	224	236	9 070 106	25
1	352	364	9 070 109	20
2	96	108	9 264 074	25
2	128	140	9 264 075	25
2	160	172	9 264 076	25
2	192	204	9 264 077	25
2	224	236	9 264 078	25
2	352	364	9 264 081	20

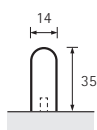
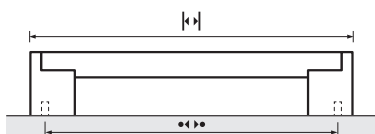

## Buena



Bright copper look

	□
9 207 445	25

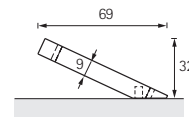
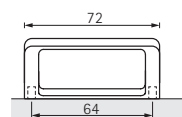

Bright copper look

	□
9 207 447	35

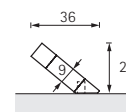
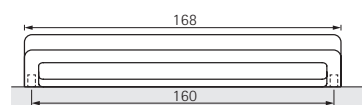

## Baldone



1 Bright chrome plated



2 Matt chrome plated



3 Brushed stainless steel look



4 Matt black

	•••	•  <sub>1</sub>	•  <sub>2</sub>	≡	□
1	96	104	11	26	9 995 546 40
1	128	136	11	26	9 995 547 30
1	160	168	11	26	9 995 780 30
1	256	264	15	29	9 995 548 25
2	96	104	11	26	9 995 482 40
2	128	136	11	26	9 995 480 30
2	160	168	11	26	9 995 782 30
2	256	264	15	29	9 995 484 25
3	96	104	11	26	9 995 483 40
3	128	136	11	26	9 995 481 30
3	160	168	11	26	9 995 781 30
3	256	264	15	29	9 995 485 25
4	96	104	11	26	9 269 733 40
4	128	136	11	26	9 269 734 30
4	160	168	11	26	9 269 735 30
4	256	264	15	29	9 269 736 25

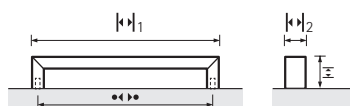

## Belluno



1 Bright chrome plated



2 Matt chrome plated



3 Brushed stainless steel look



4 Matt black

	•••	•	≡	□
1	96	130	28	0 043 643 30
1	160 / 192	200	30	0 043 503 40
1	224 / 256	267	30	0 043 506 25
2	96	130	28	0 043 642 30
2	160 / 192	200	30	0 043 502 40
2	224 / 256	267	30	0 043 505 25
3	96	130	28	9 995 771 30
3	160 / 192	200	30	9 995 772 40
3	224 / 256	267	30	9 995 773 25
4	96	130	28	9 270 437 30
4	160 / 192	200	30	9 270 438 40
4	224 / 256	267	30	9 270 439 25

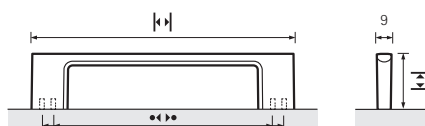

# DELUXE

## Intra



1 Matt chrome plated /  
Bright chrome plated



2 Brushed stainless steel look /  
Bright chrome plated



3 Brushed stainless steel look /  
Brushed copper look



4 Matt black /  
Brushed stainless steel look



5 Matt white / Brushed copper look



6 Matt black / Brushed copper look

1	9 105 737	25	
2	9 105 735	25	
3	9 207 480	25	
4	9 207 481	25	
5	9 207 483	25	
6	9 264 088	25	

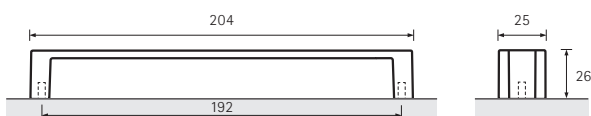



## Veronia



Brushed stainless steel look

••	k <sub>1</sub>	k <sub>2</sub>		□
128	144	14	9 065 635	50
160	176	19	9 097 946	25

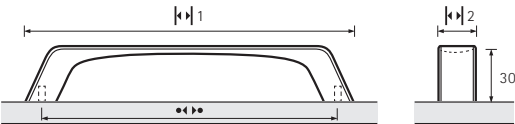

## Limpio



1 Matt White



2 Matt black

		□
1	9 266 417	25
2	9 266 418	25

## Opera



Bright chrome plated

••	k		□
96/128	135	9 113 675	50
160	200	9 113 678	25
192	232	9 113 681	25

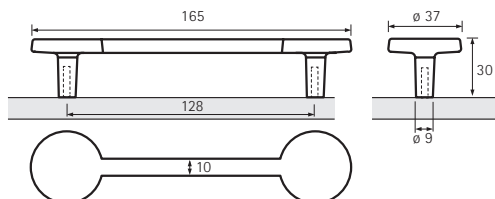

# ORGANIC



34 Tolfo



34 Coria



35 Balmo



35 Nicia



36 Ovada



36 Fectio



37 Vantania



37 Naila



38 Avenio



38 Belna



38 Vieste



39 Suasa



39 Tardiano



40 Ladera



40 Andilla



40 Issa



40 Armento



41 Cirpi



41 Esbo



41 Langa



# ORGANIC

## Tolfo



1 Bright chrome plated



2 Brushed stainless steel look

## Coria



Matt chrome plated

			☐
1	9 097 900	25	
2	9 097 899	25	

			☐
	9 112 597	50	

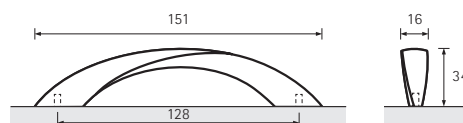
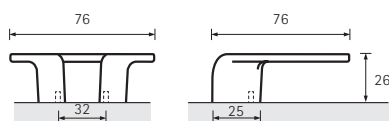

## Balmo



1 Matt chrome plated



2 Brushed stainless steel look

## Nicia



1 Bright chrome plated



2 Matt chrome plated

			☐
1	0 074 134	25	
2	0 043 472	25	

	•••		±		☐
1	128	148	30	9 071 037	50
2	128	148	30	9 071 039	50

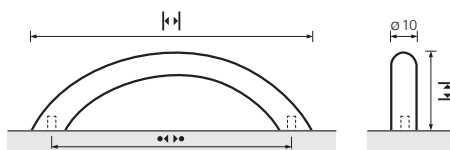
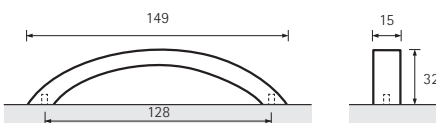

# ORGANIC

## Ovada



1 Bright chrome plated



2 Brushed stainless steel look

## Fectio



1 Matt chrome plated



2 Brushed stainless steel look

	•••			□
1	96	139	9 118 524	50
1	160 / 192	266	9 118 521	50
1	256 / 320	362	9 118 518	25
2	96	139	9 118 523	50
2	160 / 192	266	9 118 520	50
2	256 / 320	362	9 118 517	25

		□
1	9 112 615	50
2	9 112 613	50

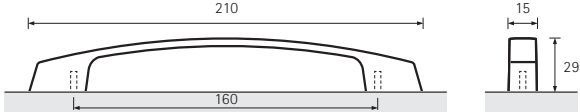
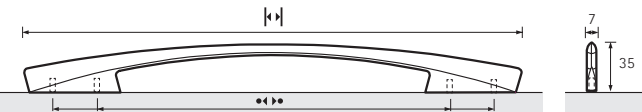

## Vantania



1 Bright chrome plated



2 Matt chrome plated



3 Brushed stainless steel look

			☐
1	9 113 211	25	
2	9 113 210	25	
3	1 170 158	25	

## Naila



Brown metallic brushed

☐	☐	☐	☐
128	135	9 190 430	50
160	167	9 190 431	50
192	199	9 190 432	50
256	263	9 190 433	50

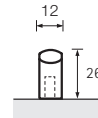
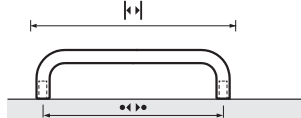
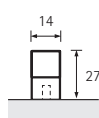
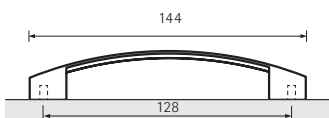

# ORGANIC

## Avenio



Matt chrome plated

## Belna



Brushed stainless steel look

∅	•••	•	□
128	135	0 115 169	50
160	167	0 115 170	50

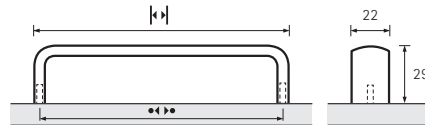

∅	•••	•	□
10	96	106	9 070 521 50
10	128	138	9 070 540 50
10	160	170	9 070 552 75
10	192	202	9 070 572 50

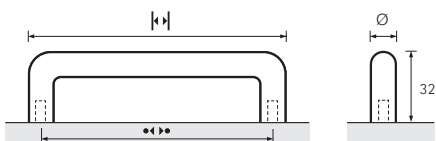

## Vieste



Brushed stainless steel look

•••	•	□
96	120	9 995 497 20
128	152	9 995 498 15
160	184	9 995 499 25
192	216	9 995 500 20
224	248	9 995 501 20

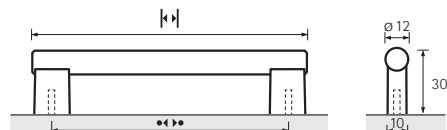



## Suasa



1 Bright chrome plated



2 Brushed stainless steel look

1	9 112 916	25	
2	9 112 915	25	

## Tardiano



1 Brushed stainless steel look



2 Matt black

1	9 266 141	25	
2	9 266 142	25	

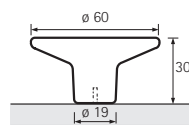
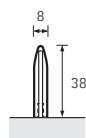
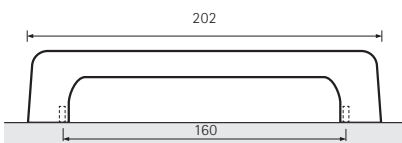

# ORGANIC

Ladera



Matt nickel plated

☐
9 112 644 50

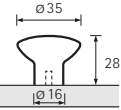

Andilla



Matt black finish

☐
160 / 192 200 9 261 817 50

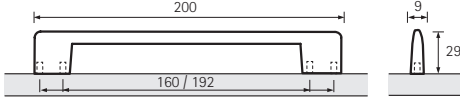

Issa



Brushed stainless steel look

☐
0 115 312 50

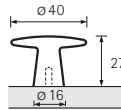

Armento



Matt black finish

☐
9 261 818 30

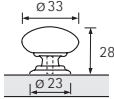

## Cirpi



1 Bright chrome plated



2 Matt chrome plated

			☐
1	9 070 585	30	
2	9 070 581	30	

## Esbo



Brushed stainless steel look

			☐
	9 190 397	50	

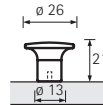
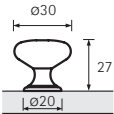

## Langa



Matt black finish

☐	☐	☐	☐	☐
96	114	29	9 261 812	30
128	146	29	9 261 813	30
160	178	29	9 261 814	40
192	210	29	9 261 815	40
256	274	29	9 261 816	50

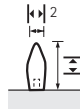
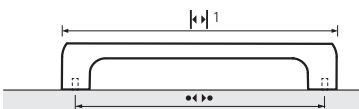

# FOLK



44 Ponzone



44 Tarraco



45 Siradia



45 Terranda

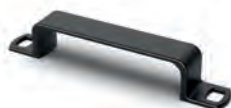

45 Topeka



46 Malaca



46 Valentia



47 Salacia



47 Eburaco



47 Savelli



47 Salemi



48 Flavia



48 Matane



49 Essa



49 Vorea



# FOLK

## Ponzone



1 Antique pewter look



2 Antique bronze look

## Tarraco



1 Pewter effect



2 Antique brass look



3 Matt black vintage

1	9 206 136	50		
2	9 113 430	50		

1	9 112 607	40	
2	9 206 137	40	
3	9 206 138	40	

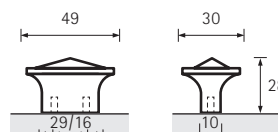
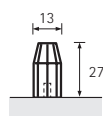
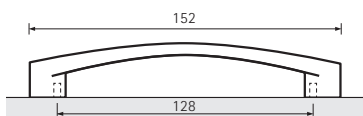

## Siradia



1 Antique pewter look



2 Antique brass look

		☐
1	9 208 026	25
2	9 208 027	25

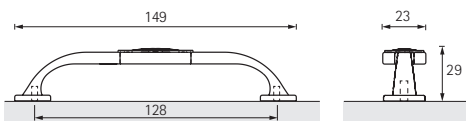

## Terranda



Brushed stainless steel look

☐	☐	☐	☐	☐
96	112	24	9 113 327	50
128	146	28	9 113 292	40

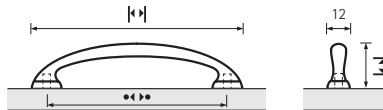

## Topeka



Matt black

☐	☐	☐	☐
128	192	9 266 420	25
160	224	9 270 230	25

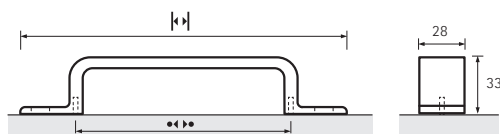

# FOLK

## Malaca



1 Pewter effect



2 Antique brass look

			☐
1	9 070 943	50	
2	9 070 945	50	

## Valentia



1 Pewter effect



2 Antique brass look

			☐
1	9 070 510	75	
2	9 070 513	75	

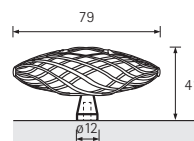
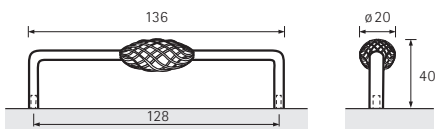



## Salacia



1 Antique silver look



2 Pewter effect

	•••	•  <sub>1</sub>	•  <sub>2</sub>		☐
1	128	151	23	9 112 594	50
2	128	151	23	9 112 591	50

## Eburaco



1 Antique silver look



2 Pewter effect

			☐
1		9 112 654	100
2		9 112 653	100

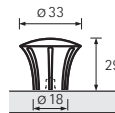
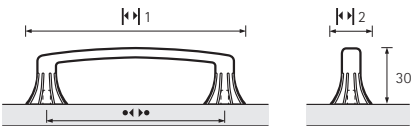

## Savelli



Brushed stainless steel look

		☐
	9 113 483	50

## Salemi



Brushed stainless steel look

		☐
	9 113 368	75

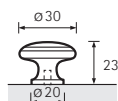
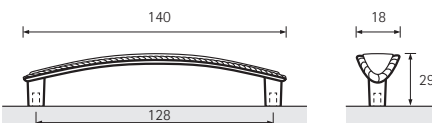

# FOLK

## Flavia



1 Matt nickel plated



2 Pewter effect

## Matane



1 Brushed stainless steel look



2 Matt black

		☐
1	0 115 293	50
2	0 115 292	50

		☐
1	9 113 228	50
2	9 260 744	50

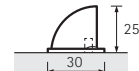
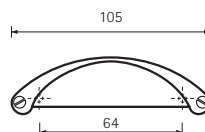
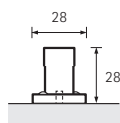
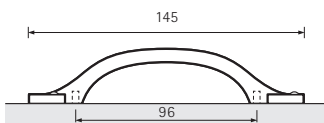

## Essa



1 Pewter effect



2 Antique brass look



3 Antique copper look



4 Antique pewter look

		□
1	9 113 222	50
2	9 113 221	50
3	9 113 223	50
4	9 113 220	50

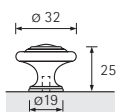

## Vorea



Matt black

•••	••	□
160/192/224	232	9 252 423 50
320	360	9 252 424 50

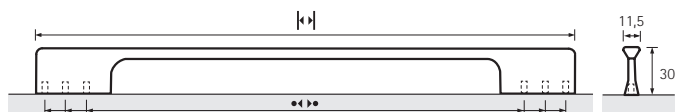

# SERVICE

## Fixing accessories



Handle fixing screws cross-slotted  
Galvanized steel

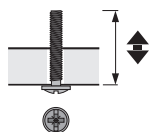

## Handle adaptor for folding/sliding doors



1 Matt chrome plated



2 Matt nickel plated

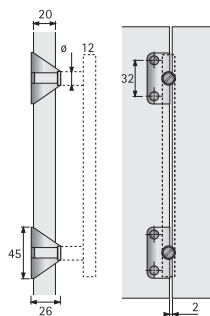

Can be used for all handle solutions on door thicknesses of up to 20 mm and a handle mounting surface greater than 12 mm in diameter.

⌘		⌘	⌘		⌘
M 4 x 14	0 071 545	50	M 4 x 30	0 071 558	50
M 4 x 16	0 071 546	50	M 4 x 32	0 071 559	50
M 4 x 18	0 071 547	50	M 4 x 34	0 071 560	50
M 4 x 20	0 071 548	50	M 4 x 36	0 071 561	50
M 4 x 22	0 071 549	50	M 4 x 38	0 071 562	50
M 4 x 24	0 071 555	50	M 4 x 40	0 071 563	50
M 4 x 26	0 071 556	50	M 4 x 42	0 071 855	50
M 4 x 28	0 071 557	50	M 4 x 45	0 071 856	50

		⌘
1	0 115 365	100
2	0 115 366	100



# SERVICE

## Accura drilling gauge

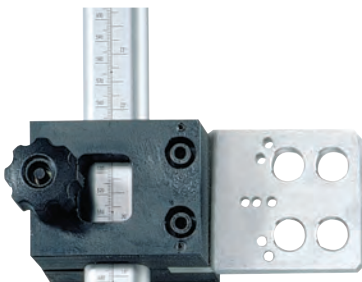

Accura - the practical and efficient universal modular drilling jig for perfect work results

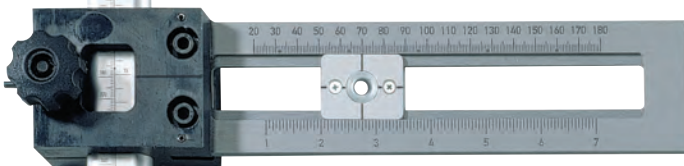

Drilling jigs for handles



Different drilling templates and stops can be positioned anywhere on the Accura rail with metric and imperial measurement scale (lengths from 500 to 2000 mm).



Markings for drilling holes for the 32 mm hole spacing system.



## Accura drilling jigs for handles

Accura drilling gauge, kit for handles contains:

- 2 Accura drill templates for handles
  - 2 drill plates with guide sleeve for 5 mm high-powered high-speed steel twist drill
  - 1 Accura slide rail with measuring scale in mm and inch, Length 500mm
  - 1 adjustable stop for front edge alignment
- ② Accura rail with metric and imperial measuring scale, with "System 32" marking points
- ↳ 500 mm
  - ↳ 1000 mm
  - ↳ 1500 mm
  - ↳ 2000 mm
- ③ Accura drill template for handles, including drilling plate with guide sleeve for 5 mm HSS twist drill bits aluminium/plastic
- ④ Replacement slide rail with drilling bushes for Accura drilling templates for handles
- ⑤ Adjustable stop for fronts and individual (dismantled) cabinet sides, plastic

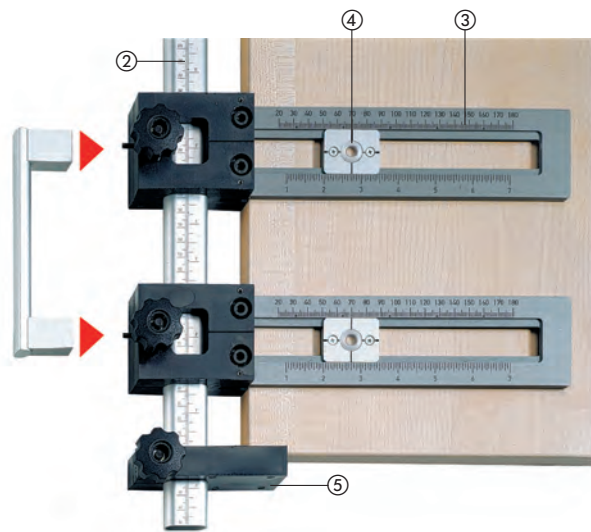

	↳		☐
		0 044 763	1
2	500	0 044 764	1
2	1000	0 070 263	1
3		0 044 765	1
4		0 044 767	1
6		0 070 266	1

# SERVICE

## Accura drilling jigs for handles

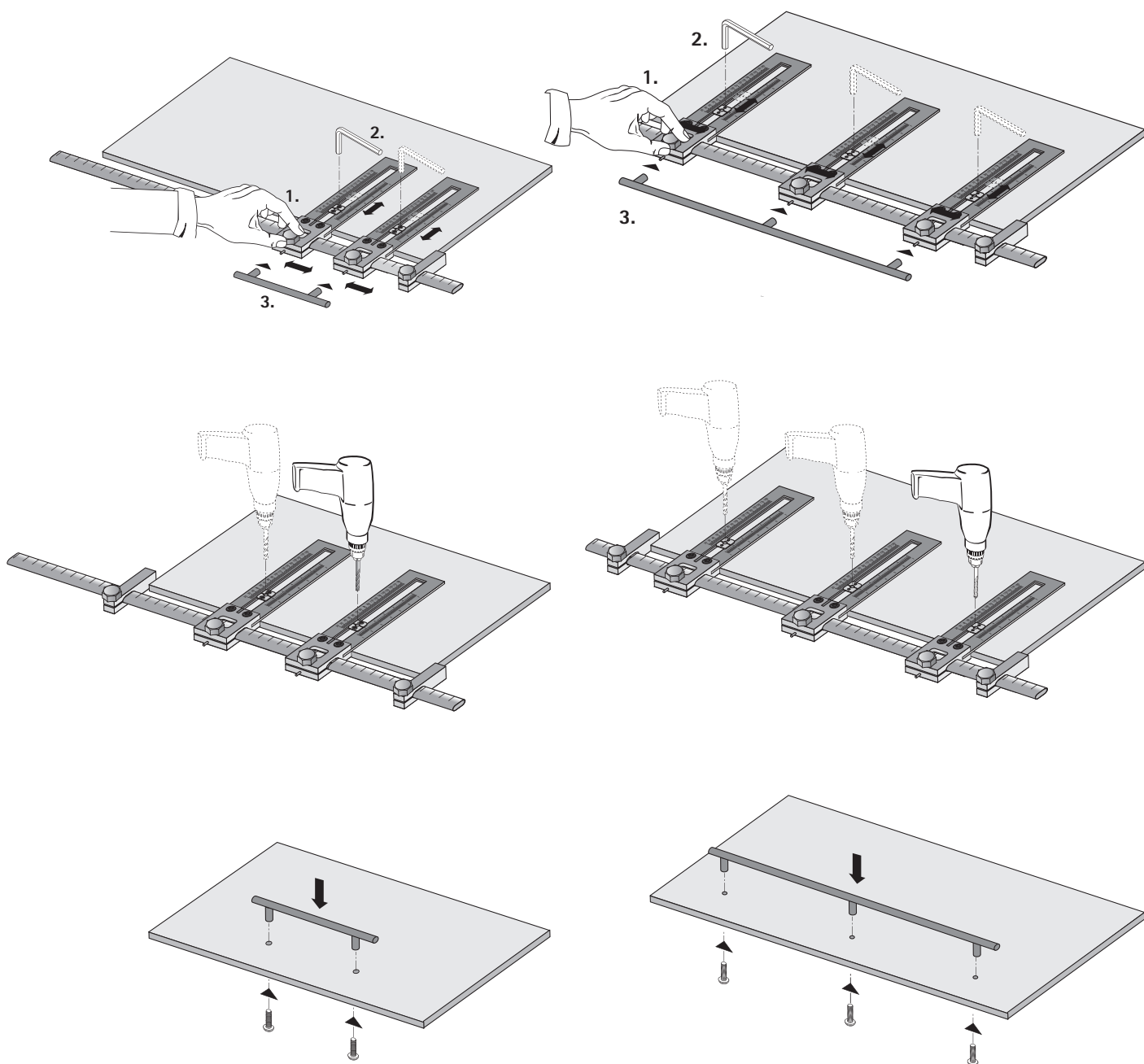



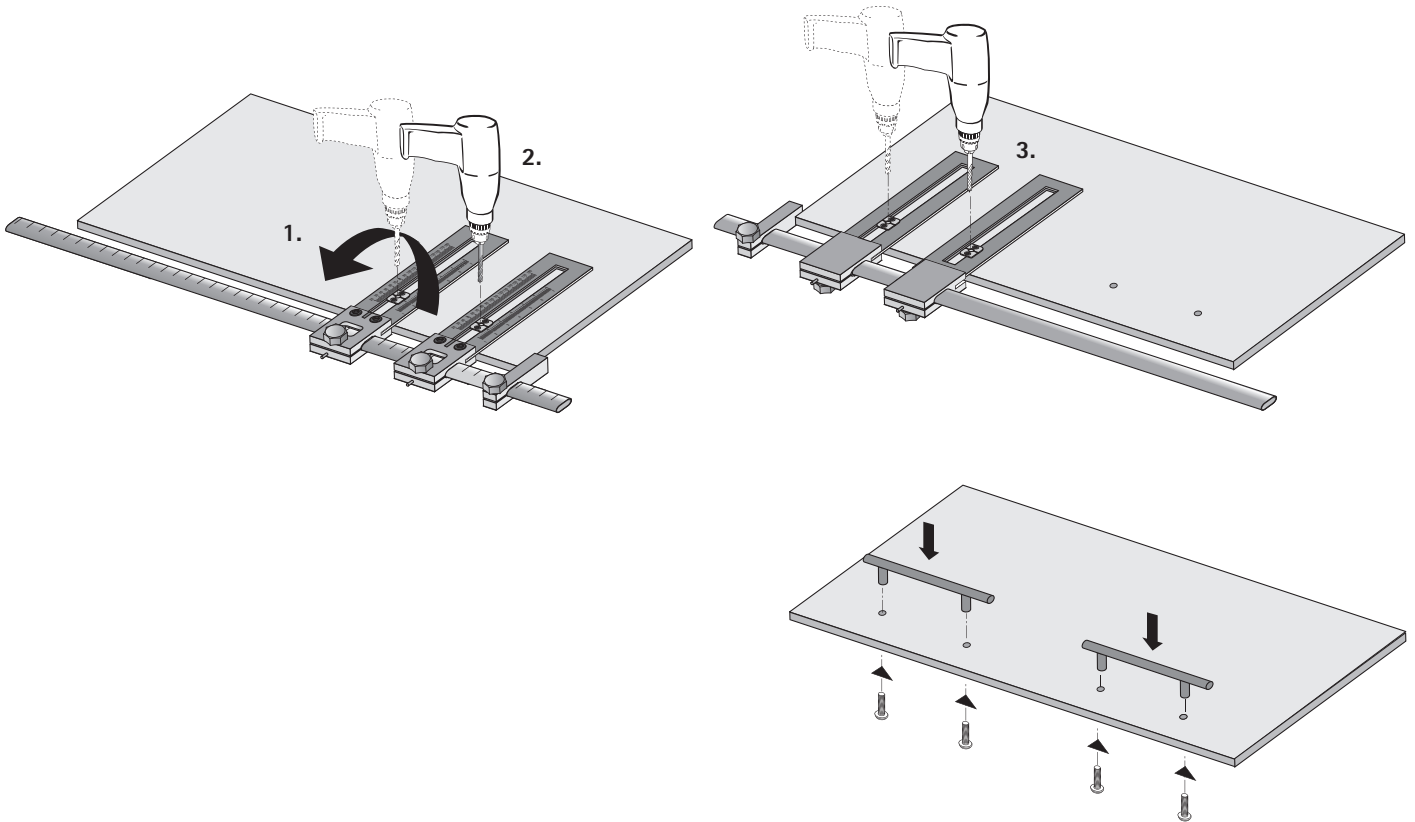

- Set chosen positioning on the front
- Set hole spacing and check using Handle fixing points
- For a handle with 2 or 3 stems: Place drilling jig on front and drill
- Screw on handle

For two symmetrically positioned handles:  
 First position drilling jig on one side to drill the holes for the 1<sup>st</sup> handle and then, without altering the setting, position drilling jig on the other side to drill the holes for the 2<sup>nd</sup> handle.

# SERVICE

## Universal hole marking template for handles and knobs

Adjustable, two-dimensional hole marking template for fast, accurate marking of System 32 hole patterns for

- Handles (Hole spacing of 32-320 mm)
- Knobs

Range of adjustment:

- Distance from drawer front side edge to first fixing hole of handle 10 - 334 mm
- Distance from drawer front top/bottom edge to position of handle 20 - 65 mm

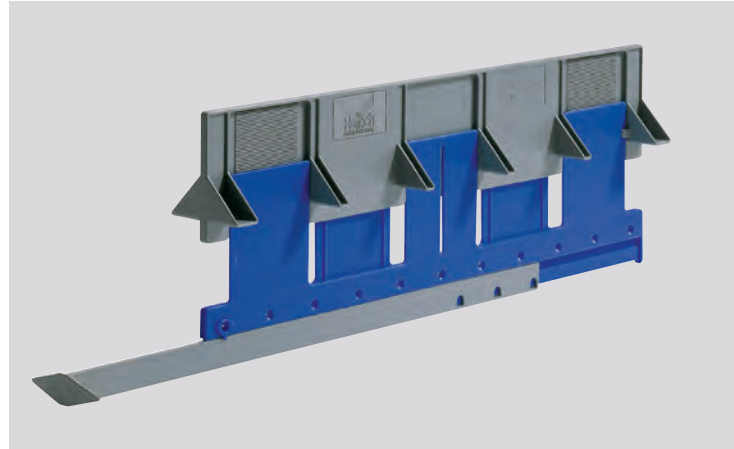

---

0 048 771 1 

---

Setting for height positioning

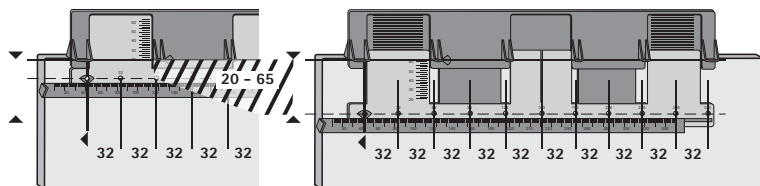

## Calculations formulae

Side positioning for a handle

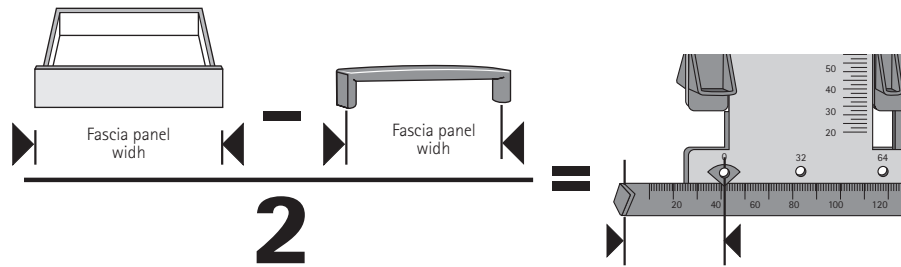

Distance from drawer front side edge to first fixing hole of handle (min. 10 mm / max. 334 mm)

Side positioning for a knob

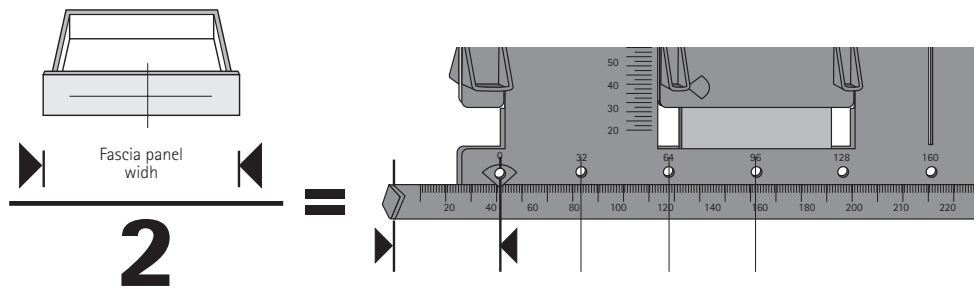

Distance from drawer front side edge to knob fixing hole (min. 10 mm / max. 334 mm)

Setting for side positioning

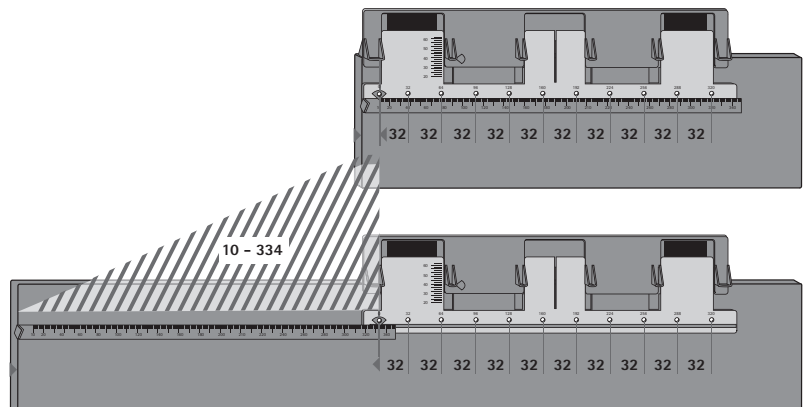

# SERVICE

## Universal hole marking template for handles and knobs

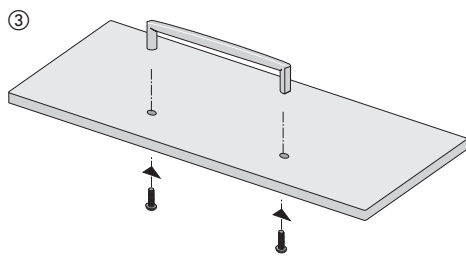
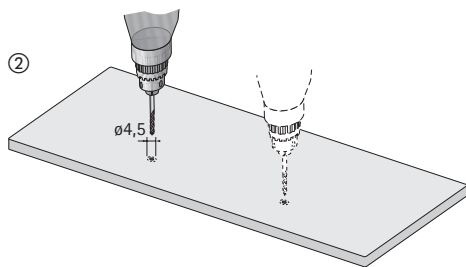
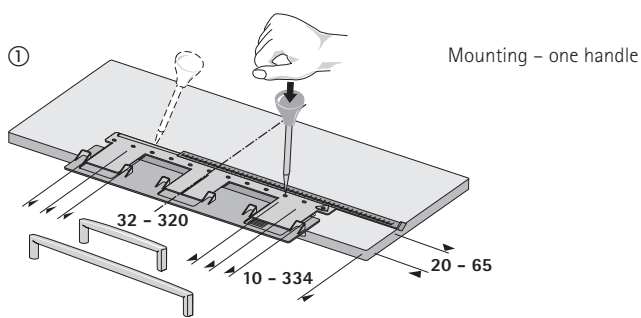

- ① Set drilling jig and mark drill hole positions
- ② Drill fixing holes
- ③ Screw on handle

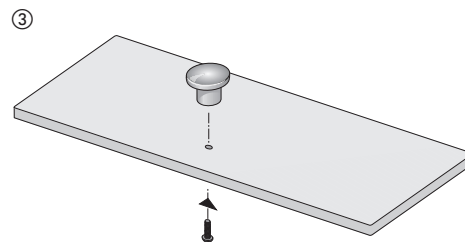
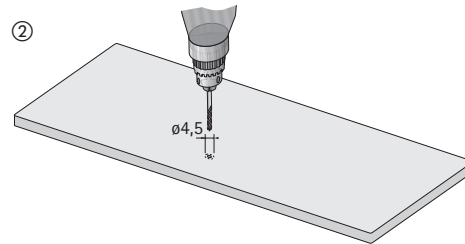
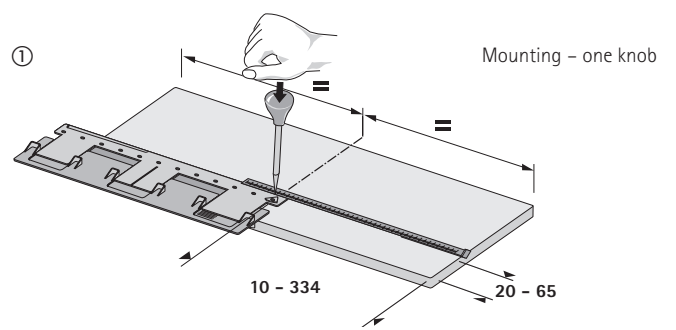

- ① Set drilling jig and mark drill hole positions
- ② Drill fixing holes
- ③ Screw on knob

The universal hole marking template can simply be used the other way round for accurately transferring hole patterns from right to left.

Mounting - two handles (positioned symmetrically)

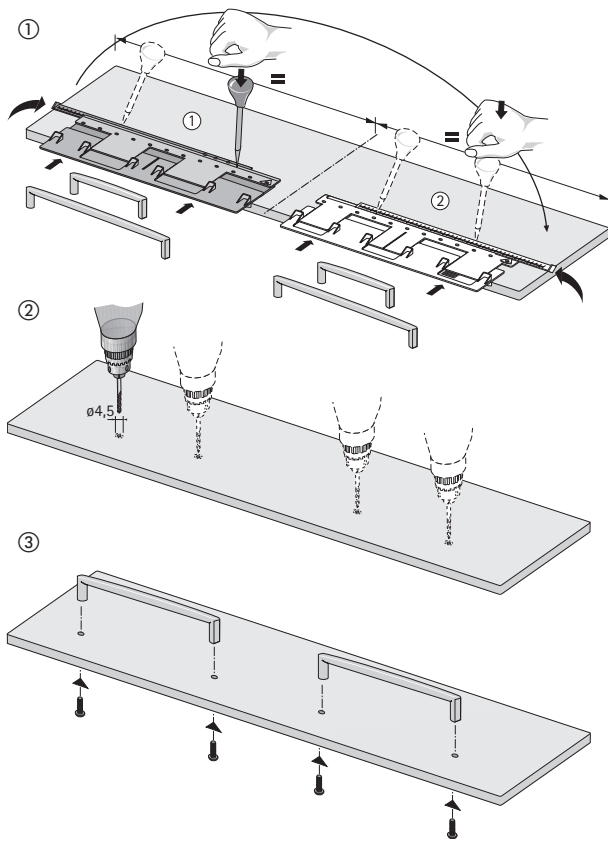

- ① Set drilling jig and mark drill hole positions
- ② Drill fixing holes
- ③ Screw on handle

Mounting - two knobs (positioned symmetrically)

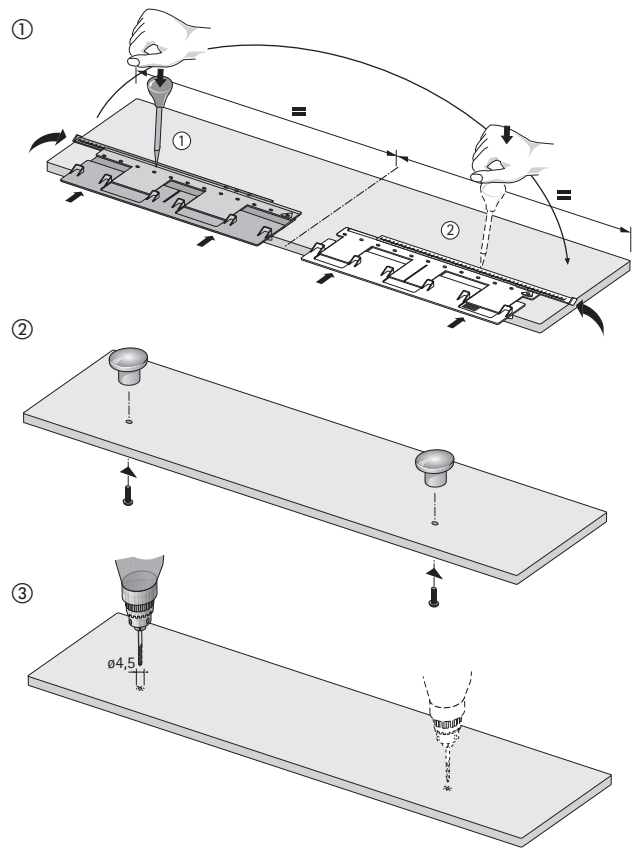

- ① Set drilling jig and mark drill hole positions
- ② Drill fixing holes
- ③ Screw on knob

The universal hole marking template can simply be used the other way round for accurately transferring hole patterns from right to left.

# INDEX

## Product-line overview arranged by materials

### Steel



13 Hale



35 Nicia



38 Avenio



46 Valentia

### Steel and Zinc



46 Malaca

### Zinc

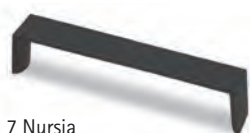

7 Nursia



10 Cheam



10 Tornea



14 Nombela



15 Padula



15 Fermo



20 Genoa



20 Messina



21 Venusia



31 Limpio



28 Buena



29 Baldone



29 Belluno



30 Intra



31 Veronia



31 Opera



34 Tolfo



34 Coria



35 Balmo



36 Ovada



36 Fectio



37 Vantania



38 Belna



38 Vieste



39 Suasa



39 Tardiano



40 Andilla



40 Armento



40 Ladera



40 Issa



41 Langa



41 Cirpi



44 Ponzone



44 Tarraco



45 Topeka



45 Siradia



45 Terranda



47 Salacia



47 Eburaco



47 Savelli



47 Salemi



48 Flavia



48 Matane



49 Essa



49 Vorea

**Aluminium**



6 Velitra



6 Imperia



8/9 Shadowline



12 Clivia



15 Kervo



16 Stabia



16 Rovigo

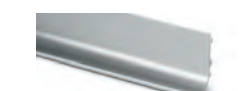

18/19 Canis L

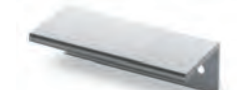

21 Ticinum



23 Lamezia



24 Lindavia



24 Lutetia



24 Eslinga



24 Seveso



37 Naila



41 Esbo

**Aluminium and Zinc**



7 Bermeo



25 Nidum

**Stainless steel**



11 Anzio



11 Aosta



13 Narona



14 Salvia



22 Narni

**Brass**



22 Empoli

**Stainless steel and Zinc**



28 Brema

# INDEX

## Product Index

Andilla	40	Salemi	47
Anzio	11	Salvia	14
Aosta	11	Savelli	47
Armento	40	Shadowline	8/9
Avenio	38	Seveso	24
Baldone	29	Siradia	45
Balmo	35	Stabia	16
Belluno	29	Suasa	39
Belna	38	Tardiano	39
Bermeo	6	Tarraco	44
Brema	28	Terranda	45
Buena	28	Ticinum	21
Canis L	18/19	Tolfo	34
Cheam	10	Topeka	45
Cirpi	41	Tornea	10
Clivia	12	Valentia	46
Coria	34	Vantania	37
Eburaco	47	Velitra	6
Empoli	22	Venusia	21
Esbo	41	Veronia	31
Eslinga	24	Vieste	38
Essa	49	Vorea	49
Fectio	36		
Fermo	15		
Flavia	48		
Genoa	20		
Hale	13		
Imperia	6		
Intra	30		
Issa	40		
Kervo	15		
Ladera	40		
Lamezia	23		
Langa	41		
Limpio	31		
Lindavia	24		
Lutetia	24		
Malaca	46		
Matane	48		
Messana	20		
Naila	37		
Narni	22		
Narona	13		
Nicia	35		
Nidum	25		
Nombela	14		
Nursia	6		
Opera	31		
Ovada	36		
Padula	15		
Ponzone	44		
Rovigo	16		
Salacia	47		



## Order Number Index

0 043 472	35	1 161 148	9	9 097 900	34	9 206 138	44	9 265 991	23
0 043 502	29	1 161 408	9	9 097 946	31	9 207 445	28	9 265 992	23
0 043 503	29	1 170 158	37	9 105 735	30	9 207 447	28	9 265 993	23
0 043 505	29	9 065 611	20	9 105 737	30	9 207 480	30	9 266 141	39
0 043 506	29	9 065 612	20	9 105 820	23	9 207 481	30	9 266 142	39
0 043 642	29	9 065 635	31	9 105 821	23	9 207 483	30	9 266 417	31
0 043 643	29	9 069 804	11	9 105 822	23	9 208 026	45	9 266 418	31
0 044 763	53	9 069 805	11	9 105 823	23	9 208 027	45	9 266 420	45
0 044 764	53	9 069 806	11	9 105 824	23	9 208 081	7	9 269 733	29
0 044 765	53	9 069 807	11	9 105 825	23	9 208 082	7	9 269 734	29
0 044 767	53	9 069 808	11	9 112 591	47	9 208 083	7	9 269 735	29
0 048 771	56	9 069 890	28	9 112 594	47	9 208 084	7	9 269 736	29
0 070 263	53	9 069 893	28	9 112 597	34	9 208 085	7	9 270 230	45
0 070 266	53	9 070 104	28	9 112 607	44	9 208 086	7	9 270 437	29
0 071 545	50	9 070 106	28	9 112 613	36	9 208 087	7	9 270 438	29
0 071 546	50	9 070 109	28	9 112 615	36	9 208 088	7	9 270 439	29
0 071 547	50	9 070 510	46	9 112 637	7	9 210 115	18	9 282 211	8
0 071 548	50	9 070 513	46	9 112 644	40	9 210 116	18	9 282 235	8
0 071 549	50	9 070 521	38	9 112 653	47	9 210 117	18	9 282 236	8
0 071 555	50	9 070 540	38	9 112 654	47	9 210 119	18	9 282 237	8
0 071 556	50	9 070 552	38	9 112 915	39	9 210 122	19	9 995 122	24
0 071 557	50	9 070 572	38	9 112 916	39	9 210 125	19	9 995 123	24
0 074 134	35	9 070 581	41	9 112 938	10	9 210 126	19	9 995 480	29
0 115 014	6	9 070 585	41	9 112 940	10	9 210 128	19	9 995 481	29
0 115 016	6	9 070 593	21	9 112 941	10	9 210 129	19	9 995 482	29
0 115 017	6	9 070 674	13	9 112 943	10	9 210 142	19	9 995 483	29
0 115 018	6	9 070 732	13	9 113 210	37	9 210 143	19	9 995 484	29
0 115 019	15	9 070 733	13	9 113 211	37	9 252 419	15	9 995 485	29
0 115 020	15	9 070 734	13	9 113 220	49	9 252 423	49	9 995 497	38
0 115 021	16	9 070 736	13	9 113 221	49	9 252 424	49	9 995 498	38
0 115 022	16	9 070 738	13	9 113 222	49	9 252 425	14	9 995 499	38
0 115 023	16	9 070 742	13	9 113 223	49	9 252 426	14	9 995 500	38
0 115 024	16	9 070 746	13	9 113 228	48	9 252 427	14	9 995 501	38
0 115 090	24	9 070 750	13	9 113 248	11	9 252 428	10	9 995 531	12
0 115 091	24	9 070 796	13	9 113 292	45	9 252 429	10	9 995 534	12
0 115 115	24	9 070 807	13	9 113 298	16	9 252 430	10	9 995 535	12
0 115 154	21	9 070 809	13	9 113 300	16	9 260 744	48	9 995 536	12
0 115 155	21	9 070 813	13	9 113 327	45	9 261 812	41	9 995 537	12
0 115 156	20	9 070 943	46	9 113 368	47	9 261 813	41	9 995 538	12
0 115 157	20	9 070 945	46	9 113 430	44	9 261 814	41	9 995 539	12
0 115 169	38	9 070 970	13	9 113 483	47	9 261 815	41	9 995 540	22
0 115 170	38	9 070 973	13	9 113 675	31	9 261 816	41	9 995 541	22
0 115 205	12	9 070 975	13	9 113 678	31	9 261 817	40	9 995 542	22
0 115 292	48	9 070 977	13	9 113 681	31	9 261 818	40	9 995 546	29
0 115 293	48	9 070 979	13	9 118 517	36	9 264 074	28	9 995 547	29
0 115 312	40	9 070 992	13	9 118 518	36	9 264 075	28	9 995 548	29
0 115 353	12	9 070 995	13	9 118 520	36	9 264 076	28	9 995 574	22
0 115 355	12	9 070 998	13	9 118 521	36	9 264 077	28	9 995 585	6
0 115 356	12	9 071 000	13	9 118 523	36	9 264 078	28	9 995 586	6
0 115 357	12	9 071 003	14	9 118 524	36	9 264 081	28	9 995 587	6
0 115 358	12	9 071 005	14	9 118 858	28	9 264 087	7	9 995 588	6
0 115 359	12	9 071 008	14	9 120 199	7	9 264 088	30	9 995 589	6
0 115 360	12	9 071 010	13	9 131 455	21	9 265 879	12	9 995 590	6
0 115 361	12	9 071 013	13	9 190 397	41	9 265 880	12	9 995 771	29
0 115 362	12	9 071 017	14	9 190 430	37	9 265 888	12	9 995 772	29
0 115 364	12	9 071 023	14	9 190 431	37	9 265 921	12	9 995 773	29
0 115 365	50	9 071 026	14	9 190 432	37	9 265 923	12	9 995 780	29
0 115 366	50	9 071 037	35	9 190 433	37	9 265 977	23	9 995 781	29
1 160 018	11	9 071 039	35	9 190 442	15	9 265 978	23	9 995 782	29
1 160 019	11	9 071 060	25	9 190 443	15	9 265 979	23	9 995 910	8
1 160 020	11	9 071 071	25	9 190 444	15	9 265 980	23	9 995 920	8
1 160 021	11	9 071 073	25	9 203 963	13	9 265 981	23	9 995 930	9
1 160 022	11	9 071 075	25	9 204 175	11	9 265 982	23		
1 160 023	11	9 071 079	25	9 204 177	11	9 265 988	23		
1 160 024	11	9 071 082	25	9 206 136	44	9 265 989	23		
1 160 025	11	9 097 899	34	9 206 137	44	9 265 990	23		

### **Publisher's imprint**

© Hettich Marketing- und Vertriebs  
GmbH & Co. KG  
32602 Vlotho, Germany

We reserve all rights to this  
catalogue under copyright law.  
It shall not be permissible to  
duplicate this catalogue in any form  
either in whole or in part without  
our written consent.  
Subject to technical alterations.  
Errors and omissions excepted.  
Subject to colour variations.

February 2020  
Order no.: 9 284 277

### **Hettich Australia**

1 Herbert Place  
Smithfield 2164, Sydney

Free Phone: 1800 687 789  
Free Fax: 1800 687 789  
[sales@hettich.com.au](mailto:sales@hettich.com.au)  
Web: [hettich.com.au](http://hettich.com.au)

### **Hettich New Zealand**

18 Barmac Place  
East Tamaki, Auckland

Free Phone: 0800 438 842 4  
Free Fax: 0800 737 847  
[sales\\_nz@hettich.co.nz](mailto:sales_nz@hettich.co.nz)  
Order online: [shop.hettich.com](http://shop.hettich.com)  
Web: [hettich.com](http://hettich.com)



Learn more about the Hettich family-owned  
company and get to know us better!

